

RESET

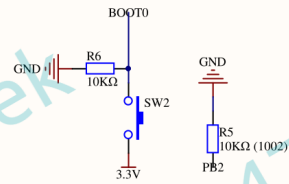

BOOT

V1.2 BOOT BOOT0

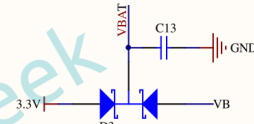

RTC

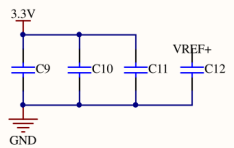
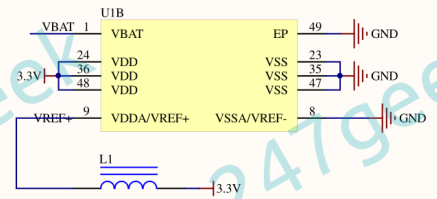

STM32

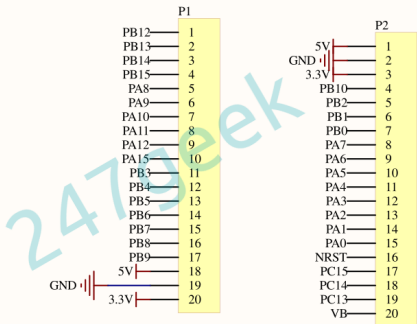
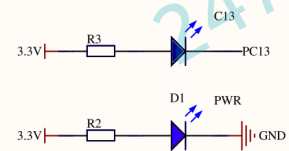

V1.1 GND 5V,

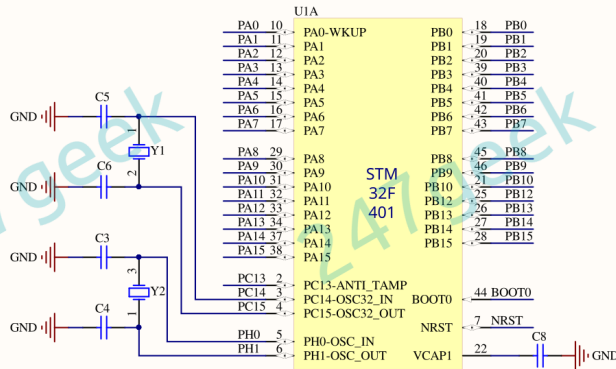

Type-C

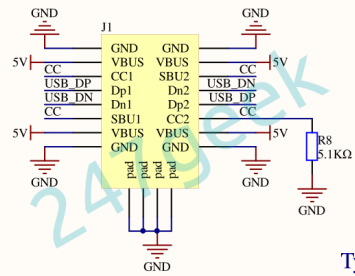

SW

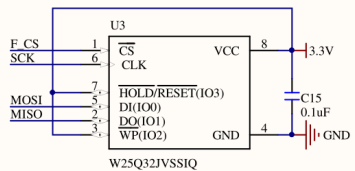
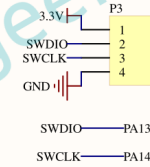

FLASH (Not Fitted)

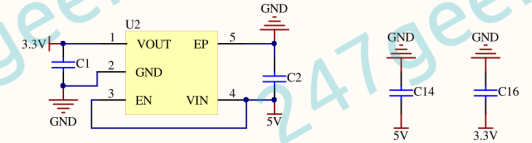

5V -> 3.3V

Title		V1.2	
MiniF4			
Size	Number	Revision	
A3			
Date:	2019/9/14/	Sheet	of
File:	E:\ADU\MiniF4xx_v2_1.2 1909.SchDoc	Drawn By:	